

Product Dimensions

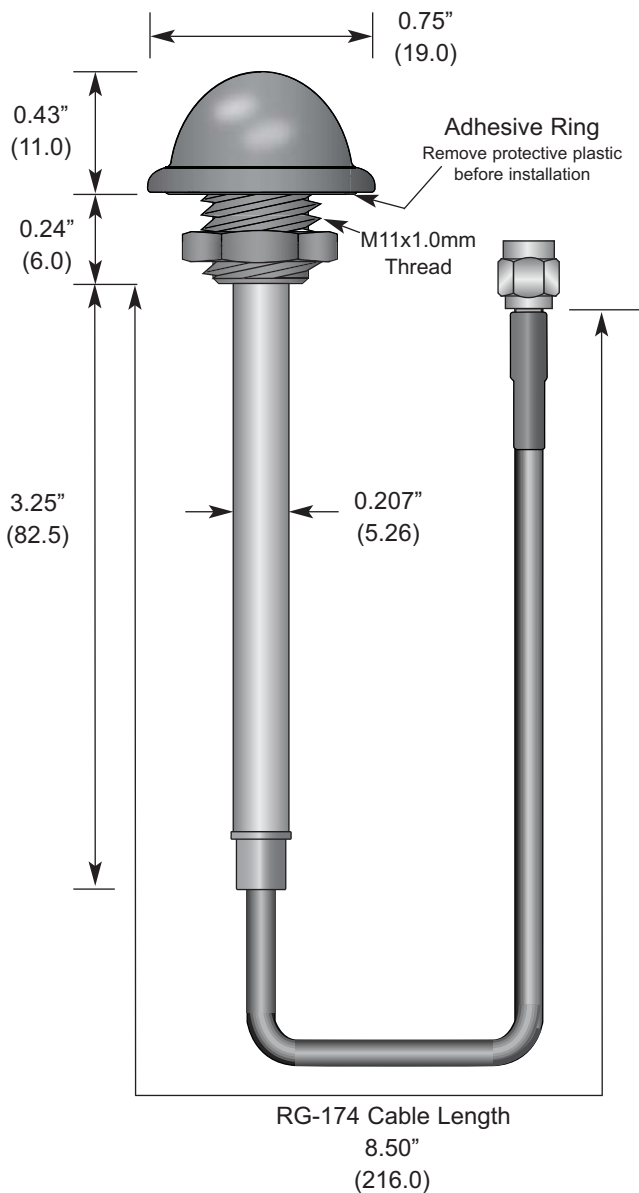

Description



The WRT Series antenna is ideally suited for applications such as wireless vending, security, traffic, or power equipment which require an unobtrusive, tamper-resistant antenna solution. The tiny 19 x 11mm radome installs through a small hole on the product and is anchored by a threaded base. An adhesive foam compression ring is used to resist the elements. The 1/4-wave antenna also features an integral counterpoise, which eliminates the need for a proximity ground plane. The antenna's coax feed is available with SMA or RP-SMA terminations. Alternate coax lengths, connectors and custom colors are available for volume OEM customers.

Features

- Low cost
- Unobtrusive
- Tamper resistant
- Integral counterpoise
- Indoor / outdoor
- Adhesive or permanent mount

Electrical Specifications

- Center Freq. 916MHz
- Bandwidth 30MHz
- Wavelength 1/4-wave
- VSWR <1.9 typ. at center
- Impedance 50 ohms
- Connector RP-SMA or SMA

Electrical specifications and plots measured on 24" x 24" reference ground plane

Ordering Information

- ANT-916-WRT-RPS (with RP-SMA connector)
- ANT-916-WRT-SMA (with SMA connector)

VSWR Graph

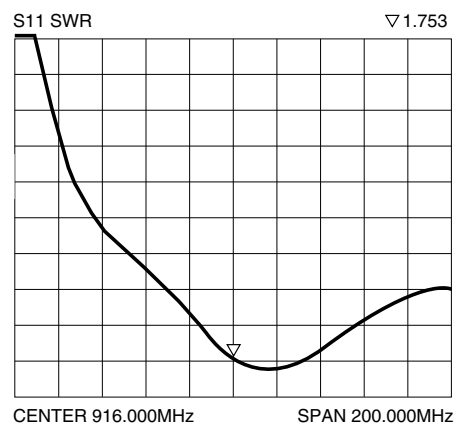

Typical VSWR